



FLASHLIGHTS & HEADLAMPS



Polígono Industrial de Matsaria, 34 · 20600 Eibar (Guipúzcoa) · Spain

Phone: (+34) 943 530 095 | (+34) 943 530 482

inpratex@inpratex.com

www.inpratex.com

EXPLOSION PROOF PRODUCTS AND SOLUTIONS FOR HAZARDOUS AREAS.

Equipment supply, Engineering and Manufacturing.

Inpratex provides a wide range of custom-made products and solutions for different industries operating in hazardous and potentially explosive environments.



Inpratex SL is based in Eibar (Gipuzkoa, Spain). We are specialists in supplying equipment, in engineering and in the manufacture of products for industries working in Hazardous Areas.

Our engineering team provides solutions combining the limitations related to the use of the equipment with the potentially dangerous environment in which it must be used.

Inpratex supplies ATEX/IECEx equipment and custom-made solutions for manufacturing and process industries.





2

FLASHLIGHTS & HEADLAMPS



2 - FLASHLIGHTS & HEADLAMPS

Inpratex provides a wide range of ATEX/IECEx certified flashlights and headlamps for safe use in potentially explosive atmospheres in industry and mining.

The range includes explosion-protected handheld and angle flashlights, headlights and portable lamps, powered by AAA batteries or rechargeable batteries.

In our catalogue you will find the right ATEX /IECEx flashlight or headlamp for use in underground manholes or galleries, sewers, basements, tanks and reservoirs, cisterns, wells, silos, chemical reactors, ship's holds, tunnels, air ducts, service galleries, pits, etc.

2.1 - FLASHLIGHTS

6

2.2 - HEADLAMPS

30

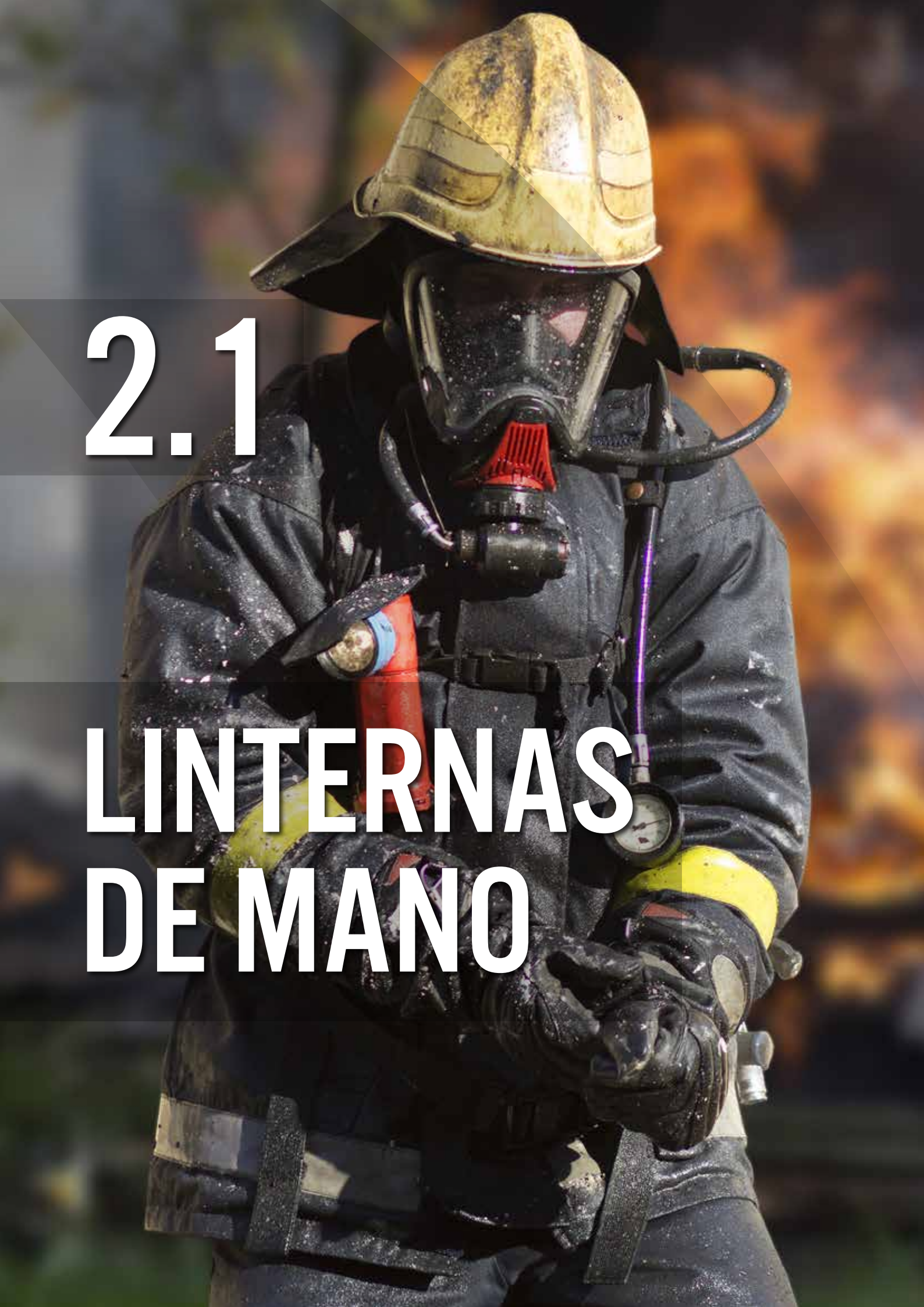

2.1

FLASHLIGHTS

EXPLOSION-PROOF MINI HAND LAMP MHL 5 EX

Zones 1, 2, 21, 22

Full catalogue available on our website: www.inpratex.com

ATEX FLASHLIGHTS

ZONES 1, 2 (gas) & 21, 22 (dust)

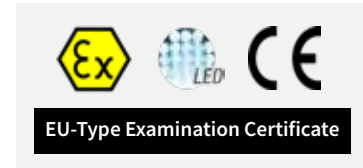

This explosion-proof high power LED lamp is made of a very impact resistant and waterproof plastic casing (IP68). The MHL 5 Ex shows its strength with bright, white light through its strong power LED.



Submersible up to 3 m.

The MHL 5 Ex is ideal for professional use as a maintenance and inspection light as well as for hazardous good transport.

ITEM REFERENCES

| Model: | Item No.: |
|----------|-----------|
| MHL 5 EX | 1F0101 |

TECHNICAL SPECIFICATIONS

| | |
|---------------------|--|
| Marking: |  II 2G Ex ib IIC T4 Gb  II 2D Ex ibD 21 T135°C Db |
| Certificate: | EU-Type Examination Certificate |
| Ingress protection: | IP68 |
| Lamp: | POWER LED |
| Operating time: | Approx. 4h |
| Luminous flux: | 42 lm |
| Range: | Approx. 30 m |
| Power source: | 2 x AAA, Micro (included) |
| Weight: | 45 g |
| Dimensions: | 145x20 mm |



2



FLASHLIGHTS & HEADLAMPS

XPP-5410G PENLIGHT

Zones 0, 1, 2

Full catalogue available on our website: www.inpratex.com

ATEX FLASHLIGHTS

ZONES 0, 1, 2 (gas) & Mines

Flashlight



This penlight is ATEX and IECEx listed Intrinsically Safe . It is ultra compact and super slim with a powerful light output designed to illuminate very tight spaces.

The tail-cap switch provides momentary or constant-on functionality. Power comes from 2 AAA premium batteries (included).

Submersible up to 1 meter.

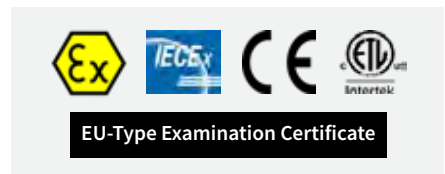

- Momentary or constant-on flashlight
- Engineered polymer housing
- Waterproof
- Built-in pocket/belt clip

- Sharp focused beam for distance illumination
- Single tail switch
- Impact & chemical resistant
- High-efficiency deep parabolic reflector

ITEM REFERENCES

| Model: | Item No.: |
|-----------|-----------|
| XPP-5410G | 1E0702 |

TECHNICAL SPECIFICATIONS

| | |
|------------------------|---|
| Marking: ATEX | I M1 Ex ia op is Ma II 1G Ex ia op is IIC T3 Ga |
| Marking: NEC 500 | CLASS I DIV 1 GRPS A-D T3 CLASS II & III DIV 1 GRPS E-G T135C CLASS I ZONE 0 AEx ia IIC T3 Ga CLASS I ZONE 0 Ex ia IIC T3 Ga |
| Certificate: | EU-Type Examination Certificate |
| Ingress protection: | IP67 |
| LED: | CREE LED (+50,000+ hours LED life) |
| Run time: | 18 h |
| Luminous flux: | 30 lm |
| Beam distance: | 40 m |
| Power source: | 2 x AAA (included) |
| Weight: | 53,9 g |
| Dimensions: | 2,3 cm (head diameter) 1,80 cm (handle diameter) 14,7 cm (length) |
| Operating temperature: | -20°C to +40°C |

XPP-5414GX DUAL-LIGHT FLASHLIGHT WITH MAGNET

Zones 0, 1, 2

Full catalogue available on our website: www.inpratex.com

ATEX FLASHLIGHTS

ZONES 0, 1, 2 (gas)



This Intrinsically Safe (cETLus, ATEX Zone 0 and IECEx) Dual-Light™ LED flashlight offers peak performance in hazardous work environments. Use the top-mounted buttons to trigger the flashlights focused distance lighting and the floodlights expansive close-up illumination.

Maximize the safety and functionality benefits by simultaneously activating both lights in Dual-Light™ Mode. Features easy-to-use top-mounted switches, durable glass-filled nylon polymer housing, an integrated magnet on base, and a reversible pocket clip.

Submersible up to 1 meter.

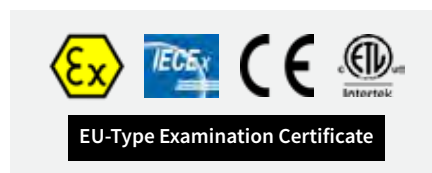

ITEM REFERENCES

| Model: | Item No.: |
|------------|-----------|
| XPP-5414GX | 1E2301 |

TECHNICAL SPECIFICATIONS

| | |
|------------------------|--|
| Marking: ATEX | Ex II 1G Ex ia op is IIC T3 Ga |
| Marking: NEC 500 | CLASS I DIV 1 GRPS A-D T3 CLASS II & III DIV 1 GRPS E-G T135°C CLASS I ZONE 0 AEx ia IIC T3 Ga CLASS I ZONE 0 Ex ia IIC T3 Ga |
| Certificate: | EU-Type Examination Certificate |
| Case material: | Engineered polymer |
| Ingress protection: | IP67 |
| Candela: | 3100cd |
| Run time: | Flashlight: 24 h Floodlight: 24 h Dual Light: 24 h |
| Luminous flux: | Flashlight: 120 lm Floodlight: 120 lm Dual Light: 120 lm |
| Beam distance: | 111 m approx. |
| Power source: | 2 x AA (not included) |
| Weight: | 116 g |
| Dimensions: | 33 mm (head diameter) 22 mm (handle diameter) 159 mm (length) |
| Operating temperature: | -20°C to +40°C |

XPP-5418GX FLASHLIGHT

Zones 0, 1, 2

Full catalogue available on our website: www.inpratex.com

ATEX FLASHLIGHTS

ZONES 0, 1, 2 (gas)

This flashlight is cETLus, ATEX Zone 0, IECEx, and INMETRO certified Intrinsically Safe for use in both above and below ground hazardous locations where explosive gases and dust may be present.

This light uses an LED rated at 200 lumens that work in conjunction with a high-efficiency deep parabolic reflector to create a usable flashlight beam rated at 143 meters. The tail switch provides momentary or constant-on functionality.

Submersible up to 1 meter.

- Momentary or constant-on flashlight
- Sharp focused flashlight beam for distance illumination
- Polymer housing
- Non-slip grip
- Dustproof/Waterproof
- Impact & chemical resistant
- Tail switch
- LED technology



EU-Type Examination Certificate

ITEM REFERENCES

| Model: | Item No.: |
|------------|-----------|
| XPP-5418GX | 1E2401 |

TECHNICAL SPECIFICATIONS

| | |
|------------------------|---|
| Marking: ATEX | II 1G Ex ia op IIC T3 Ga |
| Marking: NEC 500 | CLASS I DIV 1 GRPS A-D T3 CLASS II & III DIV 1 GRPS E-G T135C CLASS I ZONE 0 AEx ia IIC T3 Ga CLASS I ZONE 0 Ex ia IIC T3 Ga |
| Certificate: | EU-Type Examination Certificate |
| Case material: | Engineered polymer |
| Ingress protection: | IP67 |
| Candela: | 5129cd |
| Run time: | 10,5 h |
| Luminous flux: | 200 lm |
| Beam distance: | 143 m |
| Power source: | 3 x AA (not included) |
| Weight: | 153 g |
| Dimensions: | 38mm (head diameter) 19mm x 35mm (handle diameter) 142mm (length) |
| Operating temperature: | -20°C to +40°C |

EXPLOSION-PROOF HAND LAMP HL 10 EX

Zones 1, 2, 21, 22

Full catalogue available on our website: www.inpratex.com

ATEX FLASHLIGHTS

ZONES 1, 2 (gas) & 21, 22 (dust)

This explosion-proof high power LED lamp is made of a very impact-resistant and water-proof plastic casing (IP68). The innovative LED torch with a length of only 17 cm and a weight of only 167 g is the leader among comparable torches.

The user will appreciate that the bulbs will not have to be replaced any more thanks to the high lifespan of the strong, but power-saving LED lamp.

Submersible up to 5 m.



EU-Type Examination Certificate



Note: can be attached to protective helmets (helmet clamp as accessory)

ITEM REFERENCES

| Model: | Item No.: |
|---------------------------------------|-----------|
| HL 10 EX | 1F0201 |
| Helmet clamp (according to DIN 19490) | 1F0205 |

TECHNICAL SPECIFICATIONS

| | |
|---------------------|--|
| Marking: | II 2G Ex ib IIC T4 Gb II 2D Ex ibD 21 T135°C Db |
| Certificate: | EU-Type Examination Certificate |
| Ingress protection: | IP68 |
| Lamp: | Power LED |
| Run time: | Approx. 11h |
| Colour temperature: | Approx. 7000k |
| Beam distance: | Approx. 150 m |
| Power source: | 4 x AA, Mignon (included) |
| Weight: | Approx. 167 g |
| Dimensions: | 41x172 mm |



EXPLOSION-PROOF HAND LAMP HL 11 EX

Zones 0, 1, 2, 20, 21, 22

Full catalogue available on our website: www.inpratex.com

ATEX FLASHLIGHTS

ZONES 0, 1, 2 (gas) & 20, 21, 22 (dust)



EU-Type Examination Certificate



ATEX certified and waterproof flashlight. Due to the fail-safe high power LED, a bulb change is no longer needed.

Turn-on button easy to operate with gloves as well.



Extremely high brightness: 110 lumen.

Note: can be attached to protective helmets (helmet clamp as accessory)

ITEM REFERENCES

| Model: | Item No.: |
|---------------------------------------|-----------|
| HL 11 EX | 1F0203 |
| Helmet clamp (according to DIN 19490) | 1F0205 |

TECHNICAL SPECIFICATIONS

| | |
|---------------------|--|
| Marking: |  II 1G Ex ia IIC T4 Ga  II 1D Ex ia IIIC T 135°C Da |
| Certificate: | EU-Type Examination Certificate |
| Ingress protection: | IP67 |
| Lamp: | Power LED |
| Luminous flux: | 110 lm |
| Beam distance: | Approx. 150 m |
| Power source: | 4 x AA (included) |
| Weight: | Approx. 195 g |
| Dimensions: | 47x175 mm |

XPP-5422GM DUAL-LIGHT FLASHLIGHT WITH DUAL MAGNETS

Zones 0, 1, 2

Full catalogue available on our website: www.inpratex.com

ATEX FLASHLIGHTS

ZONES 0, 1, 2 (gas) & Mines



This non-rechargeable Dual-Light flashlight with dual magnets is cETLus, ATEX, INMETRO and IECEx listed Intrinsically Safe Permissible.

It uses a CREE LED rated at 120 lumens that works in conjunction with a high-efficiency deep parabolic reflector to create a usable flashlight beam rated at 170 meters. A 120 lumens unfocused floodlight is integrated into the housing which is perfect for close-up illumination. Additionally, both the flashlight and the floodlight can be turned on at the same time for maximum versatility.

Submersible up to 1 meter.



The integrated magnets located in the base of the handle and the pocket clip, provide for almost limitless hands-free usage.

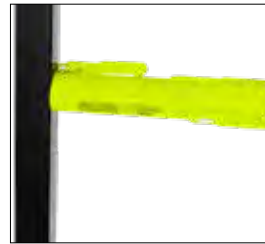

ITEM REFERENCES

| Model: | Item No.: |
|------------|-----------|
| XPP-5422GM | 1E0601 |

TECHNICAL SPECIFICATIONS

| | |
|------------------------|---|
| Marking: ATEX | I M1 Ex ia I Ma II 1G Ex ia IIC T3 Ga |
| Marking: NEC 500 | CLASS I DIV 1 GRPS A-D T3 CLASS II & III DIV 1 GRPS E-G T135C CLASS I ZONE 0 AEx ia IIC T3 Ga CLASS I ZONE 0 Ex ia IIC T3 Ga |
| Certificate: | EU-Type Examination Certificate |
| Ingress protection: | IP67 |
| LED: | CREE LED (50,000+ hours LED life) |
| Run time: | Flashlight Runtime: 17.5 h Floodlight Runtime: 17.5 h Dual-Light Runtime: 4.5 h |
| Luminous flux: | Flashlight Lumens: 120 Floodlight Lumens: 120 Dual-Light Lumens: 240 |
| Beam distance: | 170 m |
| Power source: | 3 x AA (not included) |
| Weight: | 196 g |
| Dimensions: | 4,5 cm (head diameter) 4 cm (handle diameter) 18 cm (length) |
| Operating temperature: | -20°C to +40°C |

XPP-5422GMX DUAL-LIGHT FLASHLIGHT WITH DUAL MAGNETS

Zones 0, 1, 2

Full catalogue available on our website: www.inpratex.com

ATEX FLASHLIGHTS

ZONES 0, 1, 2 (gas)



This Dual-Light Flashlight is cETLus, ATEX, IECEx and INMETRO listed Intrinsically Safe for use in both above and below ground hazardous locations where explosive gases and dusts may be present.

It uses an LED rated at 210 lumens that works in conjunction with a high-efficiency deep parabolic reflector to create a usable flashlight beam rated at 187 meters

Submersible up to 1 meter.



The integrated magnets located in the base of the handle and the pocket clip, provide for almost limitless hands-free usage.



ITEM REFERENCES

| Model: | Item No.: |
|-------------|-----------|
| XPP-5422GMX | 1E1701 |

TECHNICAL SPECIFICATIONS

| | |
|------------------------|---|
| Marking: ATEX | I M1 Ex ia I Ma II 1G Ex ia IIC T3 Ga |
| Marking: NEC 500 | CLASS I DIV 1 GRPS A-D T3 CLASS II & III DIV 1 GRPS E-G T135C CLASS I ZONE 0 AEx ia IIC T3 Ga CLASS I ZONE 0 Ex ia IIC T3 Ga |
| Certificate: | EU-Type Examination Certificate |
| Ingress protection: | IP67 |
| LED: | CREE LED (50,000+ hours LED life) |
| Run time: | Flashlight: 14 h Floodlight: 20 h Dual Light: 10 h |
| Luminous flux: | Flashlight: 210 lm Floodlight: 130 lm Dual Light: 285 lm |
| Beam distance: | 187 m approx. |
| Power source: | 3 x AA (not included) |
| Weight: | 196 g |
| Dimensions: | 45 mm (head diameter) 38x28 mm (handle diameter) 178 mm (length) |
| Operating temperature: | -20°C to +40°C |

XPR-5522GMX RECHARGEABLE DUAL-LIGHT FLASHLIGHT W/ MAGNETS

Zones 0, 1, 2

Full catalogue available on our website: www.inpratex.com

ATEX FLASHLIGHTS

ZONES 0, 1, 2 (gas)

The XPR-5522GMX Rechargeable Dual-Light Flashlight w/Dual Magnets is cETLus, ATEX, IECEx, and MSHA listed Intrinsically Safe Permissible for use in both above and below ground hazardous locations where explosive gases and dusts may be present.

It uses an LED rated at 240 lumens that work in conjunction with a high-efficiency deep parabolic reflector to create a usable flashlight beam rated at 178 meters. A 175 lumens unfocused floodlight is integrated into the housing which is perfect for close-up illumination.

Powered by an integrated Lithium-ion rechargeable battery.

Wall or Vehicle Mounted Charger included.

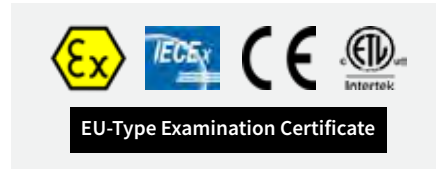

ITEM REFERENCES

| Model: | Item No.: |
|-------------|-----------|
| XPR-5522GMX | 1E1702 |

TECHNICAL SPECIFICATIONS

| | |
|------------------------|--|
| Marking: ATEX | II 1G Ex ia op is IIC T3 Ga |
| Marking: NEC 500 | CLASS I DIV 1 GRPS A-D T3 CLASS II DIV 1 GRPS E-G T3 & Class III T165°C CLASS I ZONE 0 AEx ia IIC T3 Ga ZONE 20 GROUP IIIC T165°C |
| Certificate: | EU-Type Examination Certificate |
| Ingress protection: | IP54 |
| LED: | 240 lm |
| Run time: | Flashlight: 8 h Floodlight: 8,5 h Dual Light: 4,75 h |
| Luminous flux: | Flashlight: 240 lm Floodlight: 175 lm Dual-Light: 400 lm |
| Beam distance: | 178 m |
| Rechargeable battery: | Lithium-ion |
| Weight: | 280 g |
| Dimensions: | 53 mm (head diameter) 33x43 mm (diameter) 188 mm (length) |
| Operating temperature: | -10°C to +40°C |

XPR-5542GMX RECHARGEABLE DUAL-LIGHT FLASHLIGHT W/ MAGNET

Zones 0, 1, 2

Full catalogue available on our website: www.inpratex.com

ATEX FLASHLIGHTS

ZONES 0, 1, 2 (gas)

The XPR-5542GMX Rechargeable Dual-Ligh Flashlight with Magnet is cULus, ATEX, and IECEx listed Intrinsically Safe for use in both above and below ground hazardous locations where explosive gases and dusts may be present.

It uses a CREE LED rated at 400 lumens that works in conjunction with a high-efficiency deep parabolic reflector to create a usable beam rated at 215 meters.

A 225 lumens unfocused floodlight is integrated in to the housing which is perfect for close-up illumination. Additionally both the flashlight and the floodlight can be turned on at the same time for maximum safety and versatility.

Power comes from a rechargeable Lithium-ion battery. Wall or Vehicle Mounted Charger included.



ITEM REFERENCES

| Model: | Item No.: |
|-------------|-----------|
| XPR-5542GMX | 1E1601 |

TECHNICAL SPECIFICATIONS

| | |
|------------------------|---|
| Marking: ATEX | Ex II 1G Ex ia IIC T4 Ga |
| Marking: NEC 500 | CLASS I DIV 1 GRPS A-D T4 CLASS II & III DIV 1 GRPS E-G CLASS I ZONE 0 GRP IIC T4 CLASS II ZONE 20 IIIC T135°C |
| Certificate: | EU-Type Examination Certificate |
| Ingress protection: | IP67 |
| LED: | CREE LED (50,000+ hours LED life) |
| Run time: | Flashlight - High: 10,5 h Medium: 19 h Low: 41 h Floodlight: 10,5 h Dual-Light: 10 h |
| Luminous flux: | Flashlight - High: 400 lm Medium: 170 lm Low: 80 lm Floodlight: 225 lm Dual-Light: 275 lm |
| Beam distance: | 215 m |
| Rechargeable battery: | Lithium-ion |
| Weight: | 310 g |
| Dimensions: | 4 cm (head diameter) 3 cm (handle diameter) 24 cm (length) |
| Operating temperature: | -20°C to +40°C |

EXPLOSION-PROOF RECHARGEABLE HAND LAMP FOUR LED EX

Zones 1, 2, 21, 22

Full catalogue available on our website: www.inpratex.com

ATEX FLASHLIGHTS

ZONES 1, 2 (gas) & 21, 22 (dust)

This compact and impact-resistant rechargeable torch model Four LED EX offers up to 12 hours of high-quality LED light. Four lens focussed white LED create a very bright, even light beam as a result of the most modern institute-calculated lens optic. The Four LED EX can be recharged up to 1000 times and guarantees flexibility and mobility with its integrated power plug. The lifespan of the LED lamp is nearly unlimited, thus, you do not need to replace the bulb. The robust and fall-safe plastic casing is designed for the hardest use.





EU-Type Examination Certificate

ITEM REFERENCES

| Model: | Item No.: |
|-------------|-----------|
| Four LED EX | 1F0301 |

TECHNICAL SPECIFICATIONS

| | |
|------------------------|--|
| Marking: |  II 2G Ex ib IIC T4  II 2D Ex ibD 21 T135°C |
| Certificate: | EU-Type Examination Certificate |
| Housing: | Plastic (shock-resistant) |
| Ingress protection: | IP65 |
| Lamp: | 4 LED 5 mm |
| Run time: | Approx. 12h |
| Beam distance: | Approx. 50 m |
| Rechargeable battery: | NiMH 4,8V/550mAh |
| Charging voltage: | 120V / 230V AC 50/60Hz |
| Weight: | 150 g |
| Dimensions: | 135x48x48 mm |
| Operating temperature: | -20°C to +40°C |



XPR-5580R RECHARGEABLE DUAL-LIGHT LANTERN

Zones 0, 1, 2

Full catalogue available on our website: www.inpratex.com

ATEX FLASHLIGHTS

ZONES 0, 1, 2 (gas)



EU-Type Examination Certificate



The XPR-5580R Intrinsically Safe Dual-Light lantern is a flashlight, a floodlight and a Dual-Light that is cULus, ATEX, and IECEx certified intrinsically safe.

The flashlight setting offers 3 user-selectable brightness settings of 210, 100 and 30 lumens with a 635 meter beam distance. The flashlight beam is perfect for cutting through smoke and lighting up objects at great distances. The floodlight setting has 3 user-selectable brightness settings of 200, 100 and a "Survival Mode" of 30 lumens that provides just enough light in an emergency situation with a run-time of 65 hrs.

Rechargeable Lithium-ion battery pack included.
Wall or vehicle mounted charger.

ITEM REFERENCES

| Model: | Referencia: |
|-----------|-------------|
| XPR-5580R | 1E1202 |

TECHNICAL SPECIFICATIONS

| | |
|------------------------|--|
| Marking: ATEX | II 1G Ex ia IIC T4 Ga |
| Marking: NEC 500 | CLASS I DIV 1 GRPS A-D T4 CLASS II & III DIV 1 GRPS E-G CLASS I ZONE 0 GRP IIC T4 CLASS II ZONE 20 IIIC T135° |
| Certificate: | EU-Type Examination Certificate |
| Ingress protection: | IP67 |
| LED: | CREE LED (50,000+ hours LED life) |
| Run time: | Flashlight: High 12 h Medium 19 h Survival 65 h Floodlight: High 14 h Medium 19 h Survival 65 h Dual-Light: 9 h 15 |
| Luminous flux: | Flashlight: 210 lm (High) 100 lm (Medium) 30 lm (Survival) Floodlight: 210 lm (High) 100 lm (Medium) 30 lm (Survival) Dual-Light: 300 lm |
| Beam distance: | 635 m / 257 m / 164 m |
| Rechargeable battery: | Lithium-ion |
| Recharge time: | 6 h |
| Weight: | 935 g |
| Dimensions: | 12 cm (head diameter) 12 cm (width) 14 cm (depth) 20 cm (length) |
| Operating temperature: | -20°C to +40°C |

XPR-5584GMX RECHARGEABLE LANTERN W/ MAGNETIC BASE

Zones 0, 1, 2

Full catalogue available on our website: www.inpratex.com

ATEX FLASHLIGHTS

ZONES 0, 1, 2 (gas)

The XPR-5584GMX Intrinsically Safe Rechargeable Lantern generates a scene-filling 600 lumens for an ultra-long 13 hours from four separate LEDs housed in a 180-degree articulating head for maximum versatility. Holding down the switch enables a battery-saving 250-lumen low mode, extending runtime to 25 hours when work demands extreme use. Designed and engineered as both a hand-held lantern and portable area light, the 5584 features a rear-mounted rubber base pad featuring a 25 lb. pull-force rare earth magnet for convenient hands-free, adjustable scene lighting on demand.

Constructed of thick-walled glass-filled nylon and weighing only 1219 g, the XPR-5584GMX is built to survive the harshest industrial environments. The over-molded rubber handle and carry strap provide the user superior grip and retention, while the two bright green rear-facing LEDs let others easily see your location for increased safety and awareness. The XPR-5584GMX is a cULus-certified Class I DIV 1, ATEX and IECEx certified with a charger that meets the requirements of NFPA-1901-14.1.10.2 (2016) mounted in any position. It's powered by an integrated rechargeable lithium-ion battery and comes with a charger base, AC and DC chargers and carry strap.

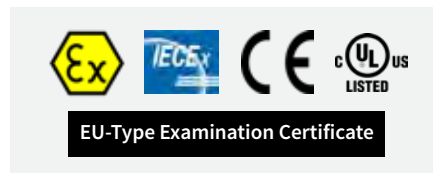

ITEM REFERENCES

| Model: | Item No.: |
|-------------|-----------|
| XPR-5584GMX | 1E2101 |

TECHNICAL SPECIFICATIONS

| | |
|------------------------|--|
| Marking: ATEX | II 1G Ex ia op is IIC T4 Ga |
| Marking: NEC 500 | CLASS I DIV 1 GRPS A-D T4 CLASS II & III DIV 1 GRPS E-G T135°C CLASS I ZONE 0 AEx ia op is IIC T4 Ga |
| Certificate: | EU-Type Examination Certificate |
| Operating temperature: | -20°C to +40°C |
| Case material: | Glass filled nylon polymer |
| Lumens/Runtime: | HIGH: 600 lm, 13 hrs. runtime LOW: 250 lm, 25 hrs. runtime |
| Candela: | HIGH: 14,096 LOW: 7,007 |
| Beam distance: | HIGH: 237 m LOW: 167 m |
| Ingress protection: | IP67 |
| Drop rating: | 2 meters |
| Dimensions: | LENGTH: 19.2 cm WIDTH: 10.8 cm DEPTH: 14.8 cm |
| Weight: | 1219 g |
| Battery: | Rechargeable Li-ion integrated battery pack |

EXPLOSION-PROOF ANGLE LAMP HL 10 EX W

Zones 1, 2

Full catalogue available on our website: www.inpratex.com

2



FLASHLIGHTS & HEADLAMPS

ATEX FLASHLIGHTS

ZONES 1, 2 (gas)

Explosion-proof angle-head hand lamp with retaining clip. Swivel diffuser for close range.

4 AA batteries included.



EU-Type Examination Certificate



ITEM REFERENCES

| Model: | Item No.: |
|------------|-----------|
| HL 10 Ex W | 1F0204 |

TECHNICAL SPECIFICATIONS

| | |
|------------------------|---------------------------------|
| Marking: | II 2G Ex ib IIC T4 Gb |
| Certificate: | EU-Type Examination Certificate |
| Ingress protection: | IP67 |
| Lamp: | 3W Power LED |
| Run time: | 10 h approx. |
| Luminous flux: | 175 lm |
| Beam distance: | 150 m approx. |
| Power source: | 4 x LR6 AA (included) |
| Weight: | 247 g (including batteries) |
| Operating temperature: | -20 °C to +40 °C |

EXPLOSION-PROOF RECHARGEABLE HAND LAMP HL 25 EX

Zones 1, 2, 21, 22

Full catalogue available on our website: www.inpratex.com

ATEX FLASHLIGHTS

ZONES 1, 2 (gas) & 21, 22 (dust)



Charging stations are not included in the delivery. These may be ordered separately as accessories.

The microprocessor controlled, rechargeable, flexible head safety lamp, model HL 25 EX, made of impact-resistant, non-flammable plastic was certified according to the ATEX directive 2014/34/EU and relevant EMC provisions and may be used in vehicles.

The lamp is equipped with two switchable high-performance LEDs: a power LED with focussed beam for far range and a 1 watt power LED with a wide emission for close range.

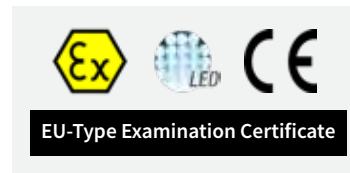

4-stage adjustable lamp head.

LCD capacity display blinks while charging.

No change of the lamp required.

Emergency light function can be turned off.



ITEM REFERENCES

| Model: | Item No.: |
|--|-----------|
| HL 25 EX (Charging station not included) | 1E0401 |
| Charging unit 100...230V AC | 1E0402 |
| Charging unit 12...24V DC | 1E0403 |
| HL 25 EX Set (Lamp + Charging unit 12...24V DC) | 1E0404 |
| HL 25 EX Set (Lamp + Charging unit 12...24V DC + 230V) | 1E0405 |

TECHNICAL SPECIFICATIONS

| | |
|-------------------------|---|
| Marking: | II 2G Ex ib IIC T4 Gb II 2D Ex ib IIIC T135°C Db |
| Certificate: | EU-Type Examination Certificate |
| Housing: | Non-flammable plastic, shock-resistant |
| Ingress protection: | IP67 |
| Lamp: | LED (170 lm) |
| Run time: | Approx. 5h |
| Beam distance: | Approx. 200 m |
| Lamp (close range): | 1 W LED (with 90 lumen) |
| Run time (close range): | Approx. 10h |
| Rechargeable battery: | Li-ion 3,7 V/4,6 Ah |
| Charging voltage: | 100...230V AC 50/60Hz, 12V DC, 24V DC |
| Weight: | Approx. 540g |
| Dimensions: | 225 x 70 x 70 |
| Operating temperature: | -20°C to +40°C |

XPP-5566RX DUAL-LIGHT ANGLE LIGHT - 3AA

Zones 0, 1, 2

Full catalogue available on our website: www.inpratex.com

ATEX FLASHLIGHTS

ZONES 0, 1, 2 (gas) & Mines



The XPP-5566RX Intrinsically Safe angle light is a flashlight, a floodlight and a Dual-Light angle light that is cULus, ATEX, and IECEx certified Intrinsically Safe. This flashlight pivots 90 degrees up and down with a 45 degree downward angled floodlight.

The flashlight setting offers user-selectable brightness settings of 200, 110 and 60 Lumens with a 401 meter beam distance.

The floodlight setting has user-selectable brightness settings of 100, 40 and a "Survival Mode" of 20 lumens that provides just enough light in an emergency situation with a run-time of 33 hours.

Powered by 3 included AA batteries.

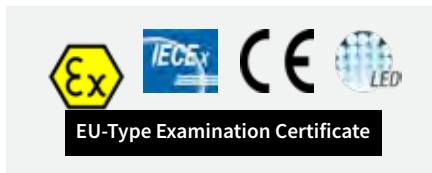

ITEM REFERENCES

| Model: | Item No.: |
|------------|-----------|
| XPP-5566RX | 1E1301 |

TECHNICAL SPECIFICATIONS

| | |
|------------------------|---|
| Marking: ATEX | I M1 Ex ia op is I Ma II 1G Ex ia op is IIC T3 Ga |
| Marking: NEC 500 | CLASS I DIV 1 GRPS A-D T3 CLASS II & III DIV1 GRPS E-G T135°C CLASS I ZONE 0 AEx ia IIC T3 Ga |
| Certificate: | EU-Type Examination Certificate |
| Ingress protection: | IP67 |
| LED: | CREE LED (50,000+ hours LED life) |
| Run time: | Flashlight: High 11 h Medium 18 h Low 33 h Floodlight: High 11 h Medium 18 h Low 33 h Dual-Light: 11 h |
| Luminous flux: | Flashlight: 200 lm (High) 110 lm (Medium) 60 lm (Low) Floodlight: 100 lm (High) 40 lm (Medium) 20 lm (Low) Dual-Light: 205 lm |
| Beam distance: | 401 m (High) 250 m (Medium) 187 m (Low) |
| Weight: | 315 g |
| Dimensions: | 53 mm (head diameter) 66 mm (width) 168 mm (length) 66 mm (depth) |
| Operating temperature: | -20°C to +40°C |

XPR-5568RX RECHARGEABLE DUAL-LIGHT ANGLE LIGHT

Zones 0, 1, 2

Full catalogue available on our website: www.inpratex.com

ATEX FLASHLIGHTS

ZONES 0, 1, 2 (gas) & Mines



The XPR-5568RX Intrinsically Safe angle light is a flashlight, a floodlight and a Dual-Light angle light that is cULus, ATEX, IECEx and MSHA certified Intrinsically Safe. The flashlight rotates 90 degrees up and down with a 45 degree downward angled floodlight.

The flashlight setting offers user-selectable brightness settings of 200, 110 and 60 Lumens with a 401 meter beam distance. The ultra-tight beam is perfect for cutting through smoke and lighting up objects at great distances. The floodlight setting has user-selectable brightness settings of 100, 40 and a "Survival Mode" of 20 lumens that provides just enough light in an emergency situation with a run-time of 27 hours.

Battery charge status indicator (only with rechargeable battery)
Rechargeable Lithium-ion Battery Pack included.
Wall or Vehicle Mounted Charger.



EU-Type Examination Certificate



ITEM REFERENCES

| Model: | Item No.: |
|------------|-----------|
| XPR-5568RX | 1E1302 |

TECHNICAL SPECIFICATIONS

| | |
|------------------------|---|
| Marking: ATEX | I M1 Ex ia op is I Ma II 1G Ex ia op is IIC T3 Ga |
| Marking: NEC 500 | CLASS I DIV 1 GRPS A-D T3 CLASS II & III DIV1 GRPS E-G T135°C CLASS I ZONE 0 AEx ia IIC T3 Ga |
| Certificate: | EU-Type Examination Certificate |
| Ingress protection: | IP67 |
| LED: | CREE LED (50,000+ hours LED life) |
| Run time: | Flashlight: High 7 h Medium 15 h Low 27 h Floodlight: High 7 h Medium 15 h Low 27 h Dual-Light: 7 h |
| Luminous flux: | Flashlight: 200 lm (High) 110 lm (Medium) 60 lm (Low) Floodlight: 100 lm (High) 40 lm (Medium) 20 lm (Low) Dual-Light: 205 lm |
| Beam distance: | 401 m (High) 250 m (Medium) 187 m (Low) |
| Weight: | 301 g (with battery) |
| Dimensions: | 53 mm (bezel diameter) 66 mm (width) 168 mm (length) 66 mm (depth) |
| Rechargeable battery: | Lithium-ion |
| Recharge time: | 4 h |
| Operating temperature: | -20°C to +40°C |

EXPLOSION-PROOF ANGLE LAMP HL 12 EX

Zones 0, 1, 2, 20, 21, 22

Full catalogue available on our website: www.inpratex.com

ATEX FLASHLIGHTS

ZONES 0, 1, 2 (gas) & 20, 21, 22 (dust)



Explosion-proof hand lamps in angle form, very bright and extremely lightweight. Two light levels and flashing mode.

Certified for all gases and dust.

The battery pack and the retaining clip can be replaced by the operator.

Inspected according to EMC provisions and is permitted for use in vehicles.

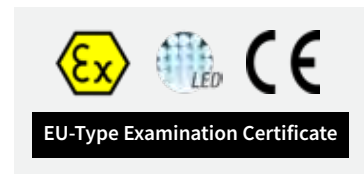

3 AA batteries included in the delivery.



ITEM REFERENCES

| Model: | Item No.: |
|----------|-----------|
| HL 12 Ex | 1E1001 |

TECHNICAL SPECIFICATIONS

| | |
|---------------------|--|
| Marking: |  II 1G Ex ia IIC T4 Ga  II 1D Ex ia IIIC T 135°C Da |
| Certificate: | EU-Type Examination Certificate |
| Lamp: | Power LED |
| Ingress protection: | IP67 |
| Switch levels: | 2 light levels + flashing mode |
| Run time: | ca. 5 h / 11 h. Capacity display |
| Luminous flux: | Approx. 200 / 55 lm |
| Beam distance: | Up to approx. 200 m |
| Power source: | 3 AA batteries (included) |
| Weight: | Approx. 280g |
| Dimensions: | 61x90x200 mm |

EXPLOSION-PROOF RECHARGEABLE ANGLE LAMP HL 12 EX

Zones 1, 2, 21, 22

Full catalogue available on our website: www.inpratex.com

ATEX FLASHLIGHTS

ZONES 1, 2 (gas) & 21, 22 (dust)

2



FLASHLIGHTS & HEADLAMPS



Explosion-proof rechargeable hand lamps in angle form, very bright and extremely lightweight. Two light levels and flashing mode.

The battery pack and the retaining clip can be replaced by the operator.

Inspected according to EMC provisions and is permitted for use in vehicles.

Capacity display.



EU-Type Examination Certificate



ITEM REFERENCES

| Model: | Item No.: |
|---|-----------|
| HL 12 Ex Rechargeable (Charging station not included) | 1E1002 |
| Charging unit 100...230V AC | 1E0402 |
| Charging unit 12...24V DC | 1E0403 |
| HL 12 Ex Set (Lamp + Charging unit 100...230V AC) | 1E1003 |
| HL 12 Ex Set (Lamp + Charging unit 12...24V DC) | 1E1004 |

TECHNICAL SPECIFICATIONS

| | |
|-----------------------|--|
| Marking: | II 2G Ex ib IIC T4 Gb II 2D Ex ib IIIC T 135°C Db |
| Certificate: | EU-Type Examination Certificate |
| Lamp: | Power LED |
| Rechargeable battery: | Li-ion 3,7 V - 2,6 Ah |
| Recharge time: | Approx. 4 h |
| Charging voltage: | 230 V AC 50/60Hz 12/24V DC |
| Ingress protection: | IP67 |
| Switch levels: | 2 light levels + flashing mode |
| Run time: | Approx. 5h / 11h |
| Luminous flux: | Approx. 200 lm / 55 lm |
| Beam distance: | Approx. 200 m |
| Weight: | Approx. 280g |
| Dimensions: | 61x90x200 mm |

EXPLOSION-PROOF ANGLE LAMP HL 35 EX

Zones 0, 1, 2, 20, 21, 22

Full catalogue available on our website: www.inpratex.com

ATEX FLASHLIGHTS

ZONES 0, 1, 2 (gas) & 20, 21, 22 (dust)



Explosion-proof LED flexible high power head lamp, for installation in vehicles or buildings.

- ATEX certified (all gases and dusts)
- Lithium-Ion-Accu (3,7 V / 5,0 Ah)
- Protection against total discharge
- LCD capacity indicator (hours and minutes)
- Emergency light function
- 3 step switch = 3 steps for brightness
- Impact-resistant, dust-proof + submersible up to 1 m
- Swivelling lamp head at 180°
- Equipped with a stable rubber protection ring
- Clamp unit with ring loop



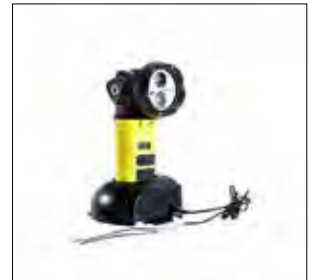

EU-Type Examination Certificate



ITEM REFERENCES

| Model: | Item No.: |
|---|-----------|
| HL 35 Ex HIGH POWER (Charging station not included) | 1E2201 |
| HL 35 Ex HIGH POWER (Lamp + Charging unit 12...24V DC) | 1E2202 |
| HL 35 Ex HIGH POWER (Lamp + Charging unit 12...24V DC + 230V) | 1E2203 |

TECHNICAL SPECIFICATIONS

| | |
|---------------------|--|
| Marking: |  II 1G Ex ia IIC T4 Ga  II 1D Ex ia IIIC T 135°C Da |
| Certificate: | EU-Type Examination Certificate |
| Housing: | Non flammable plastic. Yellow/Black |
| Ingress protection: | IP67 |
| Batteries: | Lithium-Ion-Accu (3,7 V / 5,0 Ah) |
| Charging time: | 9 h approx. |
| Operating time: | Level 1: 10 h Level 2: 5 h Level 3: 4 h (approx.) |
| Luminous flux: | Level 1: 135 lumens Level 2: 300 lumens Level 3: 380 lumens (approx.) (Lumens values may differ by +/- 10%) |
| Beam distance: | 300 m approx. |
| Weight: | 600g approx. |
| Dimensions: | 237x105x77 mm |

EXPLOSION-PROOF RECHARGEABLE HAND LAMP SLE 15 LED SET

Zones 1, 2, 21, 22

Full catalogue available on our website: www.inpratex.com

ATEX FLASHLIGHTS

ZONES 1, 2 (gas) & 21, 22 (dust)



The microprocessor controlled, rechargeable hand lamp, model EX SLE 15 LED, made of impact-resistant, high-quality plastic was certified according to the directive 2014/34/EU and relevant EMC provisions and may be used in vehicles.

The EX SLE 15 LED can be operated in a permanent, blinking and pilot lamp function and used as a warning light.



Flexible lamp head.

4-stage charge level display.

Emergency light function, turns on in the event of a power failure.

Maintenance-free led gel rechargeable battery.

12V-24V charger included.



EU-Type Examination Certificate

ITEM REFERENCES

| Model: | Item No.: |
|-------------------|-----------|
| EX SLE 15 LED SET | 1E0302 |

TECHNICAL SPECIFICATIONS

| | |
|----------------------------|---|
| Marking: | II 2G Ex ib IIC T4 Gb II 2D Ex ib IIIC T135°C Db |
| Certificate: | EU-Type Examination Certificate |
| Housing: | Plastic, shock-resistant |
| Ingress protection: | IP64 |
| Lamp: | Power LED (approx. 180 lumen) |
| Operating time: | Approx. 5h |
| Beam distance: | Approx. 150m |
| Pilot lamp: | LED 5 mm |
| Operating time pilot lamp: | Approx. 75h |
| Rechargeable battery: | Lead-gel rechargeable battery Maintenance-free |
| Charging voltage: | 230V AC 50/60Hz, 12/24V DC |
| Weight: | 1100 g |
| Dimensions: | 104x245x120 mm |
| Operating temperature: | -20°C to +40°C |

Dimensions in mm

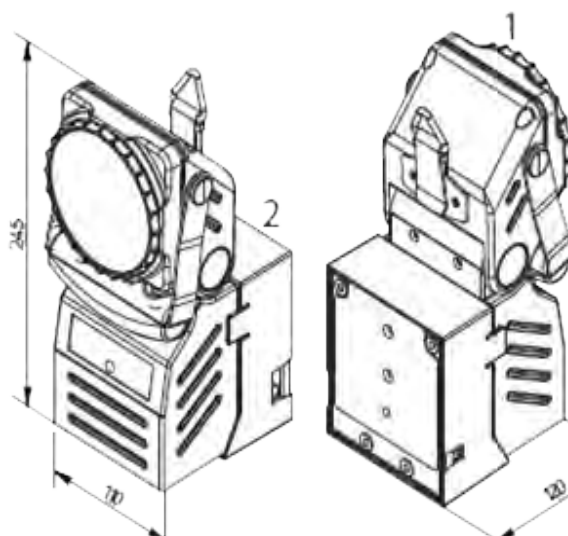

Dimensions AccuLux EX SLE 15 LED
Dimensions AccuLux EX SLE 16 LED

EXPLOSION-PROOF RECHARGEABLE HAND LAMP SLE 16 LED SET

Zones 1, 2, 21, 22

Full catalogue available on our website: www.inpratex.com

ATEX FLASHLIGHTS

ZONES 1, 2 (gas) & 21, 22 (dust)



The microprocessor controlled, rechargeable hand lamp, model EX SLE 16 LED, made of impact-resistant, high-quality plastic was certified according to the directive 2014/34/EU and relevant EMC provisions and may be used in vehicles.

The EX SLE 16 LED can be operated in a permanent, blinking and pilot lamp function and used as a warning light.



Flexible lamp head.

4-stage charge level display.

Emergency light function, turns on in the event of a power failure.

Maintenance-free led gel rechargeable battery.

12V-24V charger included.



EU-Type Examination Certificate

ITEM REFERENCES

| Model: | Item No.: |
|-------------------|-----------|
| EX SLE 16 LED SET | 1E0303 |

TECHNICAL SPECIFICATIONS

| | |
|----------------------------|--|
| Marking: | II 2G Ex ib IIC T4 Gb II 2D Ex ib IIC T135°C Db |
| Certificate: | EU-Type Examination Certificate |
| Housing: | Plastic, shock-resistant |
| Ingress protection: | IP64 |
| Lamp: | Power LED (approx. 180 lm) |
| Operating time: | Approx. 5h |
| Beam distance: | Approx. 170 m |
| Pilot lamp: | LED 5 mm |
| Operating time pilot lamp: | Approx. 75h |
| Rechargeable battery: | Lead-gel rechargeable battery Maintenance-free |
| Charging voltage: | 230V AC 50/60Hz, 12/24V DC |
| Weight: | 1100 g |
| Dimensions: | 104x245x120 mm |
| Operating temperature: | -20°C to +40°C |

Dimensions in mm

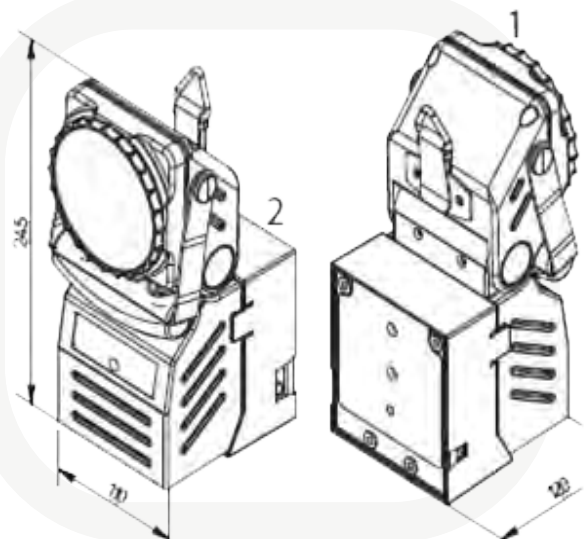

Dimensions AccuLux EX SLE 15 LED
Dimensions AccuLux EX SLE 16 LED





2.2

HEADLAMPS

XPP-5454G DUAL LIGHT HEADLAMP

Zones 0, 1, 2

Full catalogue available on our website: www.inpratex.com

ATEX HEADLAMPS

ZONES 0, 1, 2 (gas)

This 3 AAA multi-function Dual-Light headlamp is cETLus, ATEX, INMETRO and IECEx listed Intrinsically Safe.



This headlamp features a multi-position tilt head design and includes an elastic head strap with a non-slip lining and a heavy-duty rubber head strap for use on a hard hat.

The dual top mounted switches provide user-selectable high or low-brightness spotlight, high or low-brightness floodlight operation and our exclusive Dual-Light design...the ability to turn on both the spotlight and the floodlight at the same time for maximum user safety and lighting versatility.



Heavy-duty rubber strap for hard hat applications.

Power comes from 3 AAA batteries (included).



EU-Type Examination Certificate

ITEM REFERENCES

| Model: | Item No.: |
|-----------|-----------|
| XPP-5454G | 1E0801 |

TECHNICAL SPECIFICATIONS

| | |
|------------------------|---|
| Marking: ATEX | Ex II 1G Ex ia IIC T3 Ga |
| Marking: NEC 500 | CLASS I DIV 1 GRPS A-D T3 CLASS II & III GRPS E-G T135C CLASS I ZONE 0 AEx ia IIC T3 Ga CLASS I ZONE 0 Ex ia IIC T3 Ga |
| Certificate: | EU-Type Examination Certificate |
| Ingress protection: | IP67 |
| Light Source: | CREE LED (50,000 + hours LED life) |
| Run time: | Flashlight: High 5 h Low 16,25 h Floodlight: High 5,25 h Low 16,75 h Dual-Light: 3,5 h |
| Luminous flux: | Flashlight: High: 115 lm Low: 60 lm Floodlight: High: 120 lm Low: 60 lm Dual-Light: 160 lm |
| Beam distance: | 82 m / 60 m |
| Power source: | 3 x AAA (included) |
| Weight: | 94 g |
| Dimensions: | 66 x 45 x 53 mm |
| Operating temperature: | -20°C to +40°C |

XPP-5456G MULTI-FUNCTION DUAL-LIGHT HEADLAMP

Zones 0, 1, 2

Full catalogue available on our website: www.inpratex.com

2

FLASHLIGHTS & HEADLAMPS

ATEX HEADLAMPS

ZONES 0, 1, 2 (gas) & Mines



This 3 AA Dual-Light multi-function headlamp is cETLus, ATEX, IECEx and MSHA listed Intrinsically Safe permissible.

The headlamp features a multi-position tilt head design, a rear-mounted battery compartment and includes both an elastic head strap with a non-slip lining and a heavy-duty rubber strap for use with hard hats.

The top mounted dual switches provide spotlight, full-power white floodlight, half-power white floodlight and red floodlight operation.



Heavy-duty rubber strap for hard hat applications.

Power comes from 3 AAA batteries (included).



EU-Type Examination Certificate

ITEM REFERENCES

| Model: | Item No.: |
|-----------|-----------|
| XPP-5456G | 1E0901 |

TECHNICAL SPECIFICATIONS

| | |
|------------------------|---|
| Marking: ATEX | I M1 Ex ia I Ma II 1G Ex ia IIC T3 Ga |
| Marking: NEC 500 | CLASS I DIV 1 GRPS A-D T3 CLASS II & III GRPS E-G T135C CLASS I ZONE 0 AEx ia IIC T3 Ga CLASS I ZONE 0 Ex ia IIC T3 Ga |
| Certificate: | EU-Type Examination Certificate |
| Ingress protection: | IP67 |
| Light Source: | CREE LED (50,000 + hours LED life) |
| Run time: | Flashlight: 18 h White Floodlight: High 13,5 h Low 75 h Red Floodlight: 37 h Dual-Light: 6,5 h |
| Luminous flux: | Flashlight: 100 lm White Floodlight: High: 90 lm Low: 20 lm Dual-Light: 175 lm Red Spotlight: 18 lm |
| Beam distance: | 140 m |
| Power source: | 3 x AAA (included) |
| Weight: | 269 g |
| Dimensions: | 84 x 84 x 89 mm |
| Operating temperature: | -20°C to +40°C |

XPP-5460GX LOW-PROFILE DUAL-LIGHT HEADLAMP

Zones 0, 1, 2

Full catalogue available on our website: www.inpratex.com

ATEX HEADLAMPS

ZONES 0, 1, 2 (gaz)

This X-Series Intrinsically Safe low-profile Dual-Light headlamp is cULus, ATEX and IECEx listed Intrinsically Safe and is designed specifically to work on fire helmets and hard-hats that have a flip-up face shield.

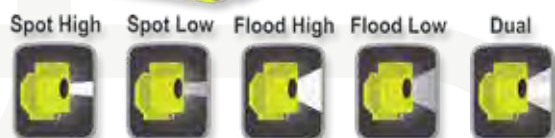

Focused high/low-brightness spotlight beam for distance illumination.
 Unfocused high/low-brightness wide-beam floodlight for close-up illumination.
 Dual-Light (spotlight and floodlight on at the same time) for maximum versatility.



EU-Type Examination Certificate

The XPP-5462GX includes a heavy-duty rubber head strap for use on a fire helmet or hard-hat, and is powered by 3 AAA batteries (included).

ITEM REFERENCES

| Model: | Item No.: |
|------------|-----------|
| XPP-5460GX | 1E1401 |

TECHNICAL SPECIFICATIONS

| | |
|------------------------|---|
| Marking: ATEX | II 1G Ex ia IIC T4 Ga |
| Marking: NEC 500 | CLASS I DIV 1 GRPS A-D T4 CLASS II & III DIV 1 GRPS E-G CLASS I ZONE 0 GRP IIC T4 CLASS II ZONE 20 IIIC T135°C |
| Certificate: | EU-Type Examination Certificate |
| Ingress protection: | IP67 |
| Lamp: | CREE LED (50,000 + hours LED life) |
| Run time: | Flashlight: High 3,5 h Low 10 h Floodlight: High 3,5 h Low 10 h Dual-Light: 3 h |
| Luminous flux: | Flashlight: High:180 lm Low 100 lm Floodlight: High 180 lm Low 100 lm Dual-Light: 200 lm |
| Beam distance: | 106 m |
| Power source: | 3 Alkaline AAA batteries (included) |
| Weight: | 165 g |
| Dimesions: | 90 x 40 x 47 mm |
| Operating temperature: | -20°C to +40°C |

XPP-5462GX LOW-PROFILE DUAL-LIGHT HEADLAMP

Zones 0, 1, 2

Full catalogue available on our website: www.inpratex.com

2

FLASHLIGHTS & HEADLAMPS

ATEX HEADLAMPS

ZONES 0, 1, 2 (gaz)

Intrinsically Safe Low-Profile Dual-Light™ Headlamp is cULus, ATEX and IECEx listed Intrinsically Safe and is designed specifically to work on fire helmets and hard-hats that have a flip-up face shield.



EU-Type Examination Certificate



Focused high/low-brightness spotlight beam for distance illumination.
 Unfocused high/low-brightness wide-beam floodlight for close-up illumination.
 Dual-Light (spotlight and floodlight on at the same time) for maximum versatility.

Submersible up to 1 meter.

The XPP-5462GX includes a heavy-duty rubber head strap for use on a fire helmet or hard-hat.

ITEM REFERENCES

| Model: | Item No.: |
|------------|-----------|
| XPP-5462GX | 1E1801 |

TECHNICAL SPECIFICATIONS

| | |
|------------------------|---|
| Marking: ATEX | II 1G Ex ia IIC T4 Ga |
| Marking: NEC 500 | CLASS I DIV 1 GRPS A-D T4 CLASS II & III DIV 1 GRPS E-G CLASS I ZONE 0 GRP IIC T4 CLASS II ZONE 20 IIIC T135°C |
| Certificate: | EU-Type Examination Certificate |
| Ingress protection: | IP67 |
| Lamp: | LED |
| Run time: | Flashlight: High 6,75 h Low 25 h Floodlight: High 7 h Low 25 h Dual-Light: 6 h |
| Luminous flux: | Flashlight: High 275 lm Low: 100 lm Floodlight: High: 250 lm Low: 100 lm Dual-Light: 310 lm |
| Beam distance: | 106 m |
| Power source: | 3 x AA batteries (included) |
| Weight: | 265 g |
| Dimensions: | 32 x 95 x 25 mm |
| Operating temperature: | -20°C a +40°C |

XPR-5562GX USB LOW-PROFILE DUAL-LIGHT HEADLAMP

Zones 0, 1, 2

Full catalogue available on our website: www.inpratex.com

ATEX HEADLAMPS

ZONES 0, 1, 2 (gaz)

The USB Intrinsically Safe Rechargeable Dual-Light Headlamp is cULus, ATEX and IECEx listed Intrinsically Safe and is designed to work on hard-hats and fire helmets that have a flip-up face shield.

The unique low-profile shape allows you to work without removing the headlamp when raising or lowering a face shield. The XPR-5562GX is manufactured from engineered polymer and features a multi-position tilt head design. Both the spotlight and the floodlight use LED technology with advanced (TIR) Total Internal Reflection lens designed to optimize lumen output and beam pattern.

Enlarged front-mounted dual switches provide easy access to the spotlight for distance illumination, the floodlight for close-up illumination, and Dual-Light for maximum lighting, versatility, and user safety.

The XPR-5562GX includes a heavy-duty rubber head strap, a 4 foot USB magnetic coupler charge card, and is powered by a Li-Ion rechargeable battery.



EU-Type Examination Certificate



ITEM REFERENCES

| Model: | Item No.: |
|------------|-----------|
| XPR-5562GX | 1E2001 |

TECHNICAL SPECIFICATIONS

| | |
|----------------------------|--|
| Marking: ATEX | II 1G Ex ia op is IIC T4 Ga |
| Marking: NEC 500 | CLASS I DIV 1 GRPS A-D T4 CLASS II & III DIV 1 GRPS E-G T135°C CLASS I ZONE 0 AEx ia op is IIC T4 Ga |
| Certificate: | EU-Type Examination Certificate |
| Operating temperature: | -20°C to +40°C |
| Case material: | Engineered polymer |
| Spotlight Lumens/Runtime: | HIGH: 275 lm, 6 hrs. runtime LOW: 100 lm, 15 hrs. runtime |
| Floodlight Lumens/Runtime: | HIGH: 250 lm, 6 hrs. runtime LOW: 100 lm, 15 hrs. runtime |
| Dual-light Lumens/Runtime: | 300 lm, 5 hrs. runtime |
| Candela: | HIGH: 3,660 |
| Beam distance: | 120 m |
| Ingress protection: | IP67 |
| Drop rating: | 2 meters |
| Dimensions: | LENGTH: 31 mm WIDTH: 95 mm DEPTH: 25 mm |
| Weight: | 164 g |
| Battery: | Integrated Li-ion |

EXPLOSION-PROOF HEADLAMP STL 1 EX

Zones 0, 1, 2

Full catalogue available on our website: www.inpratex.com

ATEX HEADLAMPS

ZONES 0, 1, 2 (gas)



STL 1 EX is a high-power LED head lamp for use in hazard zones and is equipped with three AAA alkaline batteries. The lamp has two light modes, is extremely bright and has a long operating time

Setting the tilt angle possible in locking steps.

Two brightness levels:
approx. 6.5 h / 174 lm (100%)
approx. 13 h / 90 lm (50%)

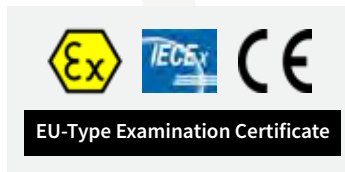

ITEM REFERENCES

| Model: | Item No.: |
|----------|-----------|
| STL 1 Ex | 1G0101 |

TECHNICAL SPECIFICATIONS

| | | |
|---------------------|--|-------------|
| Marking: | Ex II 1G Ex ia IIC T4 | |
| Certificate: | EU-Type Examination Certificate | |
| Housing: | Robust casing, screw fastening due to safety reasons | |
| Ingress protection: | IP67 | |
| Lamp: | LED CREE | |
| Luminous flux: | 174 lm (100%) | 90 lm (50%) |
| Beam distance: | Approx. 100 m | |
| Run time: | 6,5 h (100%) | 13 h (50%) |
| Power source: | 3x AAA alkaline (included) | |
| Weight: | Approx. 165 g | |



Although the information in this catalog is presented in good faith and believed to be correct at the time of printing, Inpratex makes no representations or warranties as to the completeness or accuracy of the information. All corrections made after printing the catalogue, and the updated data sheets, will be displayed on our website www.inpratex.com.

The purchaser accepts our General Conditions of Sale at the time of receipt of our confirmation and/or the acceptance of the ordered goods or services.





Polígono Industrial de Matsaria, 34
20600 Eibar (Guipúzcoa) - Spain
Phone: (+34) 943 530 095 | (+34) 943 530 482
E-mail: inpratex@inpratex.com